

# PROMAX MSX CROM

## OWNER'S MANUAL



PROMAX.SU

Congratulations on your purchase of the PROMAX MSX CROM 49CC Your motorcycle is warranted to be free of manufacturing defects in the material and workmanship for a period of 90 days from the date of purchase. During the warranty period Ricky Power Sports LLC. will at its option, repair, provide replacement parts or replace your bike at no charge. This warranty does not cover normal wear items or damage caused by neglect or misuse of the product.

Engine Warranty – 90 days

Frame Warranty – 90 days

Warranty is void if:

- Frame is bent or broken due to abuse
- Wheels are bent or broken
- Fender bent or broken due to abuse
- Any sign of impact, accident, jumping, spin-outs or roll over.

Ricky Power Sports LLC. is not liable for any damage claim or liability claim person or otherwise resulting from the operation of this product in any way.

A COPY OF THE SALES RECEIPT IS REQUIRED.



**WARNING**

**This manual should be considered as a permanent part of the vehicle and should remain with the vehicle when resold or otherwise transferred to a new user of operator. The manual contains important safety information and instructions which should be read carefully before operating the vehicle.**

# TABLE OF CONTENTS

NOTICE TO USER'S .....	2
SAFE OPERATION .....	3
PRE-RIDE CHECKLIST .....	3
SAFTY GEAR.....	4
LOCATION OF WARNING LABLES .....	5
MAIN DATA .....	6
PARTS & SUBASSEMBLES .....	7
INDICATORS .....	7
FUEL VALVE.....	9
ENGINE STARTING .....	10
BREAKING IN THE ENGINE.....	11
SWITCHES ON RIGHT HANDLEBAR.....	11
GEAR SHIFTING.....	12
CHECK-UPS, ADJUSTMENT AND MAINTENANCE .....	13
CHANGING THE OIL,CLEANING OIL FILTER SCREEN .....	13
CHECK-UP OF SPARK PLUG .....	14
VALVE INSPECTION .....	14
CHECKING & CLEANING THE AIR FILTER.....	15
ADJUSTING THE THROTTLE CABLE .....	16
ADJUSTING THE CARBURETOR.....	16
INSPECTION OF FRONT HYDRAULIC DISK BRAKE .....	17
CLUTCH ADJUSTMENT .....	18
ADJUSTMENT OF CHAIN .....	19
GREASING PROCEDURES TO THE DRIVING CHAIN.....	19
TROUBLESHOOTING .....	20
FUEL SUPPLYING CHECK.....	20
IGNITION SYSTEM CHECK.....	21
VEHICLE WASHING.....	22
INSTRUCTIONS FOR STORAGE.....	23
RESUMPTION OF SERVICE AFTER STORAGE .....	24
TABLE OF TORQUE OF FASTENERS .....	24
RESUMPTION OF SERVICE .....	24
INSPECTION AND MAINTENANCE .....	24
MAINTENANCE SCHEDULE .....	25
SERIAL NUMBER LOCATION .....	26
WIRE DIAGRAM.....	26
HMC-EMISSION CONTROL SYSTEM WARRANTY STATEMENT .....	28

## NOTICE TO USER'S

Please read this manual and follow all instructions carefully. To emphasize

special information, the symbol  and the words WARNING or CAUTION have some special meanings. Pay great attention to the messages.

### **WARNING**

- Indicates a potential hazard that could result in death or injury.

### **CAUTION**

- Indicates a potential hazard that could result in vehicle damage.

**NOTE: Indicating special information which is to make maintenance easier or instructions clearer.**

**WARNING** and **CAUTION** are arranged like this:

### **WARNING-OR-CAUTION**

- The first part will identify a POTENTIAL HAZARD.
- The second part will describe WHAT COULD HAPPEN if you ignore the WARNING or CAUTION.
- The third part will describe HOW TO AVOID THE HAZARD.

This user's manual contains important safety and maintenance information.

Read it carefully before riding. Failing to follow the warnings contained in this manual could result in INJURY or DEATH.

It is important that this manual remain with the vehicle when you transfer it to another user or owner.

All information, illustrations, photographs and specifications contained in this manual are based on the latest product information available at the time of publication. Due to improvements or other changes, there will be some discrepancies in this manual. We reserve the right to make product changes at any time, without notice and without incurring any obligation to make the same or similar changes to the vehicle previously built or sold.

## **SAFE OPERATION**

A pre-operation check must be conducted before starting the engine.

This check will insure safety, prevent mishaps, and prevent damage to components.

It is strongly suggested that all operators take a certified motorcycle rider's course prior to operating the vehicle.

Full attention is required during driving; paying close attention to the following points to avoid any injury to you by other motorized vehicles:

- Do not drive too close to other vehicles.
- This motorcycle is for one operator only.
- Driving at high speeds is the cause of many accidents; do not drive at a speed that the actual situation does not permit.

## **PRE-RIDE CHECKLIST**

1. Engine oil level

- a) Check for leaks
- b) Tighten filler cap securely.
- c) Add oil if required.

2. Fuel level

- a) Add fuel as necessary.
- b) Do not overfill (no fuel in the filler neck).
- c) Do not mix oil with gas.
- d) Replace cap tightly.
- e) Do not refuel a hot engine. Allow engine to cool before adding fuel.

3. Warning decals

- a) Make sure all warning decals are legible and securely attached.
- b) Replace as necessary.

4. Tires

- a) Ensure that both tires are in safe riding condition.
- b) Properly inflate both tires. We recommend that you inflate the tire to between 15psi and 20psi. Do not exceed 32 psi.

5. Drive chain

- a) Check condition and tension.
- b) Lubricate and adjust tension as necessary.

6. Throttle

- a) Check for smooth operation. Make sure the throttle "snaps" back to idle.

b) Check for frayed cable or damaged cable housing. Replace damaged cable.

c) Check for mud, debris and ice in the throttle cable/mechanism.

Clean out any contamination.

## SAFTY GEAR

A DOT approved motorcycle helmet is the most important part of you safety gear. A DOT approved motorcycle helmet can help prevent a serious head injury. Choose a helmet that fits snugly. Motorcycle dealers can help in selecting a good quality helmet which fits properly.

### **▲ WARNING**

- Operating this motorcycle without wearing an approved DOT motorcycle helmet, eye protection, and protective clothing could be hazardous.
- Operating without an approved DOT motorcycle helmet or eye protection increases your chances of a severe head injury or death in an accident. Operating without protective clothing also increases your chances of sever injury in an accident.
- Always wear an approved DOT motorcycle helmet which fits properly. Always wear eye protection (goggles or face shield). You should also wear gloves, boots, long sleeve shirt or jacket, and long pants.

You should wear eye protection when you ride. If a rock or a branch hits your eyes, you could be severely injured. Wear goggles or a face shield.

Wear proper clothing when you ride. The proper clothes can protect you from injury. Wear a good pair of gloves, strong boots that are over the ankle, long pants, and a long sleeve shirt.

## LOCATION OF WARNING LABELS

Read and follow all of the warnings labels on your motorcycle. Make sure you understand all the labels. Keep the labels on the motorcycle. Do not remove them for any reason. If a label come off or become difficult to read, you should get a replacement by contacting Ricky Power Sports LLC or your dealer.



1

### **⚠ WARNING**

No one under the age of 16 should operate this vehicle without adult supervision.

2

### **⚠ WARNING**

- Study the owners manual carefully
- Always wear a helmet, eye protection and protective riding gear.
- Do not drive while drinking alcohol or while on medication.

## MAIN DATA

DESCRIPTION	DATA	DESCRIPTION	DATA
Payload	150Kg	Spark plug	DR8EA(Torch) Gap:0.6~0.8mm
Ground clearance	165mm	Front wheel	120/70-12
Max speed	87Km/h	Rear wheel	130/70-12
Transmission	5Gea	Ignition means	C.D.I.
Capacity of fuel tank	6.4L	Brake	Front: Disc
Oil capacity	1.1L		Rear: Disc
Lubrication method	Pressure, splash	Sprocket	428H-106
Clutch	Manual / Wet	Battery	12N7L-4B



## PARTS & SUBASSEMBLES

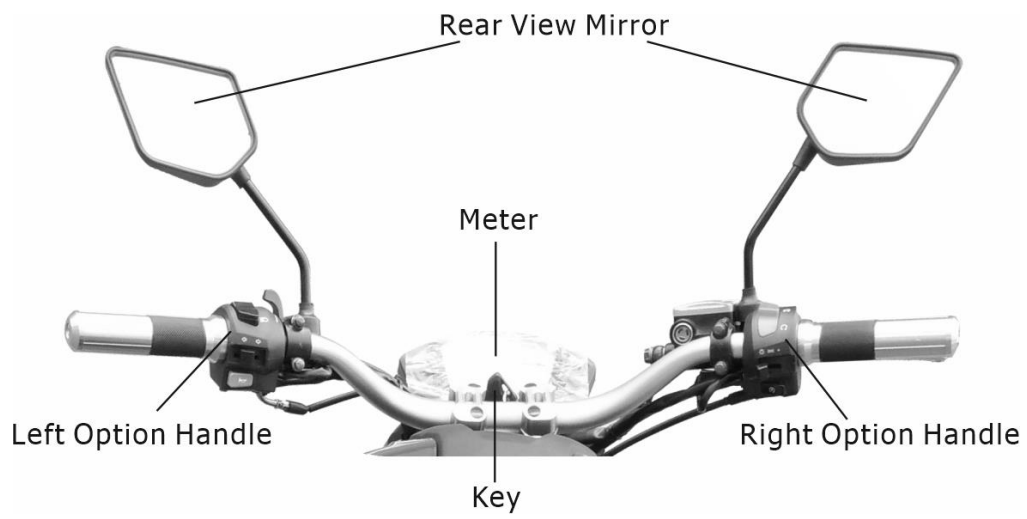

## INDICATORS

The indicators on your motorcycle help make you aware of possible issues, refer to them often.



**Speedometer** - Shows the speed you are traveling miles per hour.

**Odometer** - Tracks the total miles driven.

**Trip meter** - Tracks the total miles driven on your trip.

**High beam indicator** - Illuminates when high beam lights are on.

**Turn signal indicator** - Flashes when left/right turn signal is on.

**Neutral indicator** - Illuminates when transmission is in neutral.

**Setup button** – Set the vehicle instrument to display TOTAL or TRIP. In trip state, press and hold to clear.

# FUEL VALVE

## Fuel filling

The capacity of the fuel tank is 6.4L. Unscrew the gas cap by turning it counter clockwise and carefully fill the tank with unleaded gasoline through the opening. DO NOT MIX GAS AND OIL TOGETHER, THIS IS A 4-STROKE ENGINE. Replace the gas cap by carefully aligning the threads on the cap and the tank and turning the cap clock wise. Wipe any spilled fuel from the dirt bike using a cloth and dispose of the cloth properly. DO NOT SMOKE OR REFUEL THE VEHICLE NEAR OPEN FLAMES OR NEAR HEATING UNITS.

ONLY REFUEL THE VEHICLE IN OPEN AREAS TO REDUCE THE LIKELIHOOD OF THE BUILD UP OF GASOLINE FUMES.

Operation of the fuel valve (the valve under the fuel tank)

ON: With the handle of the fuel valve at "ON" position, the fuel supply will flow to the carburetor.

OFF: With the handle of the fuel valve at "OFF" position, the fuel supply will not flow to the carburetor.

RES: If fuel level in the fuel tank becomes too low for engine to stay running while fuel valve is at "ON" position, turn fuel valve to "RESERVE". Turning fuel valve to "RESERVE" will allow engine to begin using reserve fuel supply.

You will need to re-fuel as soon as possible. There is approximately 1L of fuel left in tank when fuel valve is placed at "RESERVE". Once re-fueled, turn fuel valve back to the "ON " Position



Fuel Valve ON



Fuel Valve OFF



Fuel Valve RESERVE

## ENGINE STARTING

### ⚠ CAUTION

- Verify oil level prior to starting.
- Starting the engine with low or no oil will damage the engine.

### ⚠ WARNING

- Never start the engine in a closed place as the exhausted gas from the vehicle contains toxic carbon monoxide.

Set the key of the ignition switch to  position.

1. Put the motorcycle in the neutral gear.
2. Ensure that there is fuel in the tank.
3. Set the fuel valve handle to "ON" or "RES" position.

To start a cold engine:

1. Pull up the choke lever of the carburetor (to open the choke).
2. Start the engine with start button or kick starter.
3. Slightly turn the throttle twist grip to increase the speed of the engine so as to warm up the engine.
4. Turn the carburetor choke bar downward to fully close the choke when the engine is sufficiently warmed up.

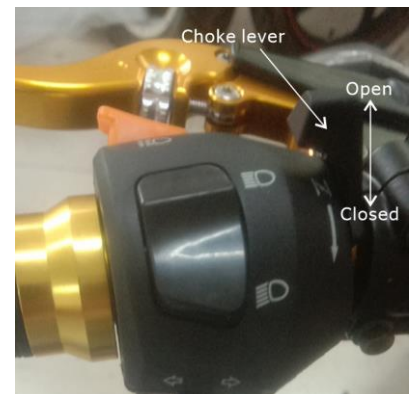

### ⚠ CAUTION

- Unnecessarily increasing RPM's to a high level while the motorcycle is in neutral is harmful to the engine.

Procedures for stopping the engine:

1. Release the throttle twist grip to slow down the engine.
2. Shift to the neutral position.
3. Set the ignition switch key to  position.
4. Set the fuel valve handle to "OFF" position.

## BREAKING IN THE ENGINE

The first 30~50 Miles of operation should be considered the "Break-in" period and special attention shall be paid to the following points:

1. Take special care not to increase the RPM's of the engine while climbing steep slopes. Never drive your motorcycle continuously for more than 50km (30 miles) without increasing and decreasing the throttle.
2. The engine shall be warmed up for 3-5 minutes prior to operation so all components are lubricated sufficiently.
3. The driving speed shall not be over 40 kmph (25 MPH) maximum during the first 500 km (300 miles) of operation and not over 65 kmph (40 MPH) maximum during the remaining 500 km (300 miles) of the "Break-In" period.

## SWITCHES ON RIGHT HANDLEBAR

### Ignition switch

The ignition switch is Located on the right handlebar.

When the switch is turned to  (off) position, the engine will not start. If the engine is running and the Off button is pushed the engine will turn off.

When the switch is turned to  (on) position, the engine can start by using the electric start or kick start lever.

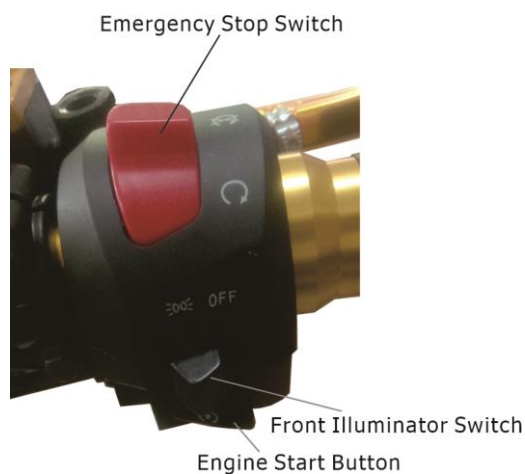

## GEAR SHIFTING

Reduce throttle before shifting. Never increase the throttle while shifting gears.

Pull in the clutch lever, located on the left hand grip.

Depress the Shift lever to place the gear in 1st, lift up the lever to shift to 2nd, 3rd, 4th and 5th.

Do not place your foot on the gear-shifting pedal while operating the motorcycle to avoid clutch damage caused by accidental gear shifting.

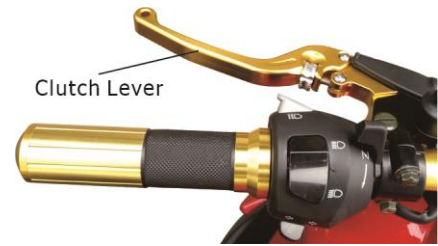

Shifting sequence

- (1) 1st gear
- (N) Neutral
- (2) 2nd gear
- (3) 3rd gear
- (4) 4th gear
- (5) 5th gear

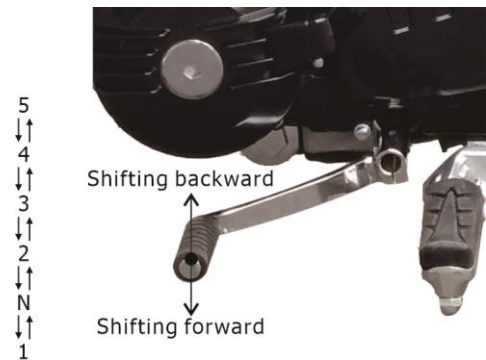

Points for Attention during Drive

1. To warm the engine let engine idle. Do not rev the engine to prevent damage to the engine components.
2. The clutch will wear out quickly if the motorcycle is operated with the clutch in a semi-engaged position.
3. Shift to the low speed gears when you feel that there is insufficient power to climb hills or continue forward.
4. Do not use the front brake only or coast using the neutral gear especially when descending or driving at a high speed.
5. Decrease the throttle when braking.

# CHECK-UPS, ADJUSTMENT AND MAINTENANCE

## Checking the Oil

Check the engine oil each time prior to operating the motorcycle.

The oil level should be between the upper and lower lines of the oil sight gauge located on the right cover of the crankcase. The level can also be checked on the dip stick.

Oil fill cap and dip stick



1. Set the motorcycle on level ground, look at the sight gauge for current oil level. Remove the oil gage plug, wipe the oil gage rod clean and then insert the gage plug into the crankcase again to check the oil level. There is no need to completely install the oil gage plug in the crankcase fill hole.
2. Add lubricating oil up to the upper line when needed, but do not overfill.
3. Finally screw on the oil gage plug tightly.

### CAUTION

- Never start the engine when there is insufficient lubricating oil. Otherwise, it will cause harm to the engine.

## Lubricating Oil Recommended

The lubricating oil is an important factor affecting the performance and service life of the engine. Please refer to the chart for the correct grade of engine oil based on the environmental conditions in your area. Do not use any other type of oil other than what is recommended in the chart. DO NOT MIX OIL WITH THE GASOLINE.

Lubricating oils of different viscosity shall be employed in different regions and at different temperatures.

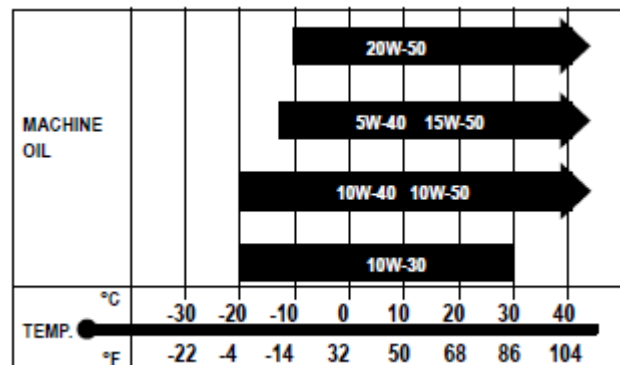

## CHANGING THE OIL, CLEANING OIL FILTER SCREEN

1. Stop the engine and let the oil drain into an approved collection container.

DO NOT PERFORM THIS PROCEDURE WHILE THE ENGINE IS HOT.

SERIOUS BURNS COULD RESULT FROM CONTACT WITH HOT OIL.

2. Dispose of the used oil properly. For proper disposal procedures, contact your local oil recycling center.
3. Clean oil screen and spring with solvent.
4. Clean and replace the oil drain plug making sure it is secure.

Check the oil level in the engine by using the oil gauge plug and/or sight gauge.



## CHECK-UP OF SPARK PLUG

1. Remove the cap of spark plug and screw off the spark plug using the plug wrench.
2. Clean the spark plug all around or replace it if it is corroded or there is too much deposit on it.
3. Regulate the gap of the spark plug to 0.6-0.8mm. (.024 inches - .032 inches)

The spark plug of the designated type should be used. The applicable type of spark plug: DR8EA (Torch) or equivalent



## VALVE INSPECTION

Refer to maintenance schedule in this owner's manual for valve adjustment inspection intervals .

Valve clearance should be:

Intake: 0.02-0.03mm

Exhaust: 0.03-0.05mm

The engine will make excess noise if the gap is too large in air valve. If gap is too small valve operation will be hindered which could result in valve malfunction and failure. Therefore, air valve gap must be checked periodically.

If you have the proper tools and are mechanically proficient, instructions on adjusting the valve clearance are given in the service manual. If assistance is needed please contact dealer to find your local service center.



## CHECKING & CLEANING THE AIR FILTER

Air filter is located under left side plastic cowling. Cowling will need to be removed.

Take the air filter out and check to see if it is dirty or torn.

Remove foam element and wash with water and allow it to dry per instructions below.

Apply a few drops of machine oil. Squeeze it with a dry cloth to remove excess oil.



Air Filter Position



Air Filter



Air Filter Assy.



Removal of foam filter element

Recommended oil:

SAE 15W-40

### **CAUTION**

- The air filter element must be intact or the engine will suck in dust and dirt, resulting in a shorter service life of the engine.
- Water should be prevented from entering into the filter when washing the vehicle.
- The filter element shall be cleaned gently without twisting to prevent it from cracking. Never wash it with gasoline or acid, alkaline or organic volatile oil to avoid its aging, which will result in reducing the effect of the air filter oil to catch particles before they enter the engine. Replace the filter element with a new one if it is broken or cracked.

## ADJUSTING THE THROTTLE CABLE

Make sure the throttle works normally.

Check if the throttle twist grip has the required free operating movement.

The required free operating movement: 2-6mm (0.078 inches - 0.24 inches) If the grip cannot be moved freely, turn the adjusting nut located near the throttle twist grip to ensure proper operating movement.

After adjustment, start the engine and check for the operating movement again. Repeat the adjustment if necessary until the desired operating movement is obtained.



Adjustment Nut



Idle Speed adjusting screw

## ADJUSTING THE CARBURETOR

Adjusting procedures of idling speed:

1. Support the vehicle by a stand.
2. Adjust the idling speed by the special designed tool to  $1500 \pm 150$ r/min.

### ⚠ CAUTION

- Do not try to correct a malfunction carburetor by adjusting the idling speed. If the carburetor is not functioning properly, it should be repaired by dealer.
- Adjust idling speed only when the engine is warmed up or 10 minutes after operation.



Special designed tool

## INSPECTION OF FRONT HYDRAULIC DISK BRAKE

1. Inspect the front disk brake caliper for leakage. If brake fluid leaks, the safety of riding could be affected.
2. Inspect the brake hose for cracks, and the joint for leakage.
3. Check the brake fluid level in the brake fluid reservoir, if level is at or below the LOWER mark, inspect brake pads for wear and hydraulic system for leaks.
4. To add brake fluid, unscrew the 2 screws on top of the brake fluid container. Add DOT3 or DOT4 brake fluid. Do not mix brake fluid types.

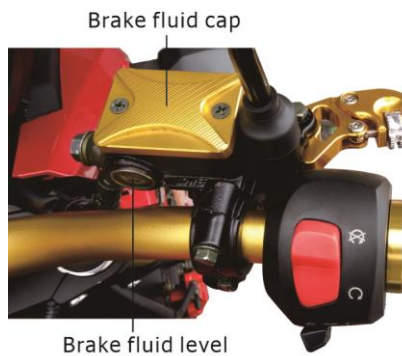

## FRONT HYDRAULIC DISK BRAKE INSPECTION REAR HYDRAULIC DISK BRAKE INSPECTION

1. Inspect the rear disk brake caliper for leakage. If brake fluid leaks, the safety of riding could be affected.
2. Inspect the brake hose for cracks, and the joint for leakage.
3. Check the brake fluid level in the brake fluid reservoir, if level is at or below the LOWER mark, inspect brake pads for wear and hydraulic system for leaks.
4. To add brake fluid, unscrew cap on top of brake fluid container. Add DOT3 or DOT4 brake fluid. Do not mix brake fluid types.

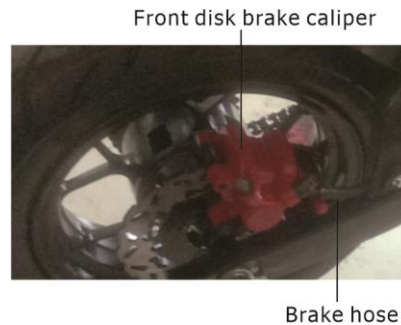
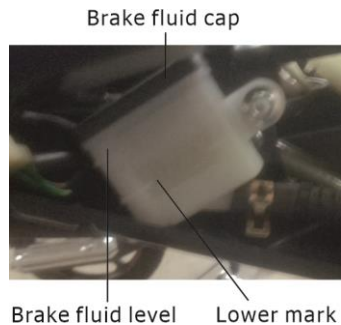

## CLUTCH ADJUSTMENT

To adjust the clutch lever play:

1. Remove the adjuster cover (slide back on cable).
2. Loosen adjuster nut and move adjuster in or out to obtain the correct play.
3. Tighten adjuster nut
4. Recheck the clutch lever free distance.

Readjust it if it is not within the correct limits.

To adjust the clutch:

1. Loosen adjuster nut and move adjuster in or out to obtain the correct tension.
2. Tighten adjuster nut
3. Recheck the clutch lever free distance.

Readjust it if it is not within the correct limits.



Clutch lever adjustment nut



Clutch adjustment nut

## ADJUSTMENT OF CHAIN

1. When chain adjustment is needed, loosen rear axle nut .
2. Turn the chain adjusting brackets on the left and right sides to adjust the tension of the chain and to align the marking of the chain adjuster with the engraved lines in the similar position on both sides.
3. Tighten rear axle nut by a torque of 50-60Nm (37-44 ft.lb.).
4. Repetitively check the tension of the chain.

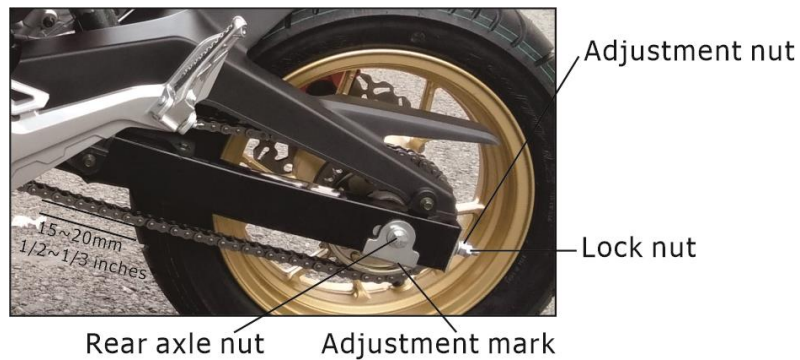

## GREASING PROCEDURES TO THE DRIVING CHAIN

1. Shut off the engine
2. Add light amounts of machine oil or chain grease to the driving chain.

(Too much machine oil or chain grease may cause splattering to occur.)

Attention:

The chain should be replaced when the adjusting limit has reached it's maximum.

## TROUBLESHOOTING

This troubleshooting guide is provided to help you to find the cause of some common complaints.

**COMPLAINT:** Engine is hard to start or does not start at all. Something is probably wrong with the fuel system or ignition system.

### ▲ CAUTION

- Failing to troubleshoot a problem correctly would damage your motorcycle.
- Improper repairs or adjustments may damage the vehicle. Such damage may not be covered under warranty. If you are not sure about the proper action, consult your dealer. About the problem.

## FUEL SUPPLYING CHECK

1. Make sure there is adequate fuel in the fuel tank.
2. Check that the engine stop switch is in the "RUN " position.
3. Check that the fuel valve is in the "ON" position.
4. Make sure there is enough fuel reaching the carburetor from the fuel tank.

### ▲ WARNING

- Draining fuel from the carburetor could be hazardous.
- Fuel could catch fire if you do not handle it properly.
- When draining the carburetor, be sure to shut the engine off. Do not smoke, and never drain or refuel or you may create a fire hazard. Dispose of drained fuel properly.

- a. Loosen the drain screw which is located under the carburetor. Drain the fuel from the carburetor into a container.
- b. Tighten the drain screw.
- c. Run the engine for a few seconds. Shut off engine.
- d. Loosen the drain screw and check that the carburetor is filled back up with fuel.
- e. If fuel is reaching the carburetor, the ignition system should be checked next.

## IGNITION SYSTEM CHECK



1. Remove the spark plug and reattach it to the spark plug lead.
2. Turn ignition key to the "RUN" position. Slide the engine stop switch to the "Run" position. Push the start button.

If the ignition system is operating properly, a blue spark should jump across the spark plug gap. If there is no spark, take your machine to your dealer.

### **▲WARNING**

- Performing the spark test improperly could be hazardous.
- You could get a high voltage electrical shock if you are not familiar with this procedure.
- Do not perform this check if you are not familiar with the procedure.
- Do not point the spark plug near the spark plug hole during this test.
- Do not do this test if you have a heart condition or wear a pacemaker.
- Do not perform this test is any near any open fuel containers for near fuel which has spilled on the ground, on the engine, or any part of the motorcycle.

### COMPLAINT: Engine stalls

1. Make sure there is enough fuel in the fuel tank.
2. Check to see that the spark plug is not fouled. Remove the spark plug and clean it. Replace it, if necessary.
3. Make sure the fuel valve is not clogged, and the fuel tank is not clogged, either.
4. Check the idle speed. If necessary, adjust it using a tachometer. The correct idle speed is 1500±150r/min.
5. Make sure the air filter is clean.

## VEHICLE WASHING

Cleaning the vehicle regularly can slow down the color fading of its body and make it easier to check if there is any damage and any oil leakage.

### **▲ CAUTION**

- Washing the motorcycle with over-pressurized water may cause damage to some of its components. Therefore, do not use a pressure washer to clean the vehicle. The following parts should be cleaned using low pressure water:

- Wheel hub
- Exhaust pipe
- Fuel tank and lower portion of cushion
- Carburetor
- Ignition Switch
- Air filter

1. After pre-wiping, the vehicle should be washed with clean water to remove dirty residues so as to prevent corrosion. Plastic subassemblies should be cleaned by wiping with a cloth or foam soaked in neutral detergent solution, followed by washing with clean water.
2. After the cleaned vehicle is air dried, grease the chain and run the engine at idling speed for a few minutes.
3. Prior to driving, carefully check the braking system repeatedly and repair or adjust it if necessary.



## INSTRUCTIONS FOR STORAGE

If the vehicle is not going to be used for a long period of time, for example, in winter time, some steps should be taken to prevent malfunction of and damage to its components which might be caused by long storage. Before storing the vehicle for a long period, proper maintenance has to be done.

1. Change engine oil and clean oil and air filters.
2. Drain off fuel from the fuel tank and carburetor, spray atomized anti-rust oil onto the inside wall of the tank and then close the tank. Dispose of any drained fuel properly so as not to adversely affect the environment.

Attention:

If the storage will last for more than one month, fuel in the carburetor must be fully drained. This will help ensure that the carburetor maintains its normal performance after the storage.

### **▲WARNING**

- Gasoline is flammable and may cause fire and even an explosion under certain conditions. Therefore, do not smoke, make a fire or have any fire around while draining off fuel.

3. Take out the spark plug, pour about 15-20ml (.5 - .68 oz.) of clean engine oil into the cylinder, start the engine several times so as to have machine oil distributed inside the engine and finally fit the spark plug back on.
4. Wash the vehicle clean, wipe it dry and apply an even coat of wax to the painted surface and a coat of anti-rust oil on the chrome-plated surfaces.
5. Inflate the tires as required and put the vehicle up on wooden blocks with the two wheels clearing the ground.
6. Put the vehicle in a shady and cool place free from humidity and direct sunlight and cover it properly (not with plastic or other painted materials).

If there is a garage, store it within.

## RESUMPTION OF SERVICE AFTER STORAGE

1. Remove the covering and remove the wooden blocks used in storing the vehicle. Change the engine oil if the vehicle has been out of service for over 4 months.
2. Drain off the remaining atomized anti-rust oil from the fuel tank, followed by filling it with fresh gasoline therein.
3. Prior to driving, all the required check-ups must be made. It is better to drive it at a low speed in an open area to test its performance before normal operation.

## TABLE OF TORQUE OF FASTENERS

Ser. No.	Fastener	Torque (Newton/m) (Foot/lb)
1	Nut for tightening upper joining plate of front fork with vertical tube	40~50Nm (30~37 ft.lb.)
2	Nuts for fixing engine	20~25Nm (15~18 ft.lb.)
3	Bolt for tightening upper joining plate of front fork with shock absorber	15~20Nm (11~15 ft.lb.)

## RESUMPTION OF SERVICE

1. Remove the covering and clean the vehicle. Change the lubricating oil if the vehicle has been off service for more than 4 months.
2. Drain off the anti-rust solution from the fuel tank, followed by filling fuel therein to the required level.
3. Prior to driving, test the vehicle at a low speed in a safe place.

## INSPECTION AND MAINTENANCE

It is very important to inspect and maintain your motorcycle regularly.

Follow the guidelines in the chart. The intervals between periodic services in months are shown. At the end of each interval be sure to perform the maintenance listed.

## MAINTENANCE SCHEDULE

Maintenance period Items	Odometer (km)					
	1000	4000	8000	12000	16000	Everyday check before riding
**Engine Oil	R	R	R	R	R	I
**Spark Plug		I	I	R	I	
**Valve Gap		A	A	A	A	
**Idle Speed		A	A	A	A	
*Engine Bolt		I	I	I	I	
*Oil Filte		C	C	C	C	
*Fuel Filter		R	R	R	R	
*Air Cleaner		C	C	R	C	
*Drive Chain		I\L	I\L	I\L	I\L	
Throttle Operation		I	I	I	I	
Brake Shoes/Pad Wear		I	I	I	I	
Brake System		I	I	I	I	
Brake Light Switch		I	I	I	I	
Brake Liquid		I	I	I	I	
Clutch		I	I	I	I	
Suspension		I	I	I	I	
Nuts, Bolts, Fasteners		I	I	I	I	
Wheel/Trye		I	I	I	I	

To keep the performance good, the motorcycle should be checked and maintained at certain interval. The meanings of capital in following table are:

I: Inspection, including check, clean, lubricate, refuel, repair or replacing if necessary.

A: Inspection, adjusting if necessary    C: Cleaning    R: Replacing    L: Lubricate

“\*” means: This item of maintenance should be carried out at a service center. It may be also done by the user with reference to this manual provided special tools and authorized spare parts are used. The user must also be capable of completing the procedure.

“\*\*” means: This item can only be carried out by an authorized service center in order to ensure safety.

### Notes:

1. Maintenance should be conducted more frequently when the motorcycle is driven in dusty areas.
2. When the vehicle has exceeded the maximum figures specified in the table, maintenance should be still cycled according to the intervals of mileage stated herein.

## SERIAL NUMBER LOCATION

You need to know the frame and engine serial numbers to get title documents for your motorcycle. You also need these numbers to help your authorized service center or Ricky Power Sports LLC. order parts.

The Frame number is stamped on front of motorcycle frame. The engine number is located on the left side of the engine housing.

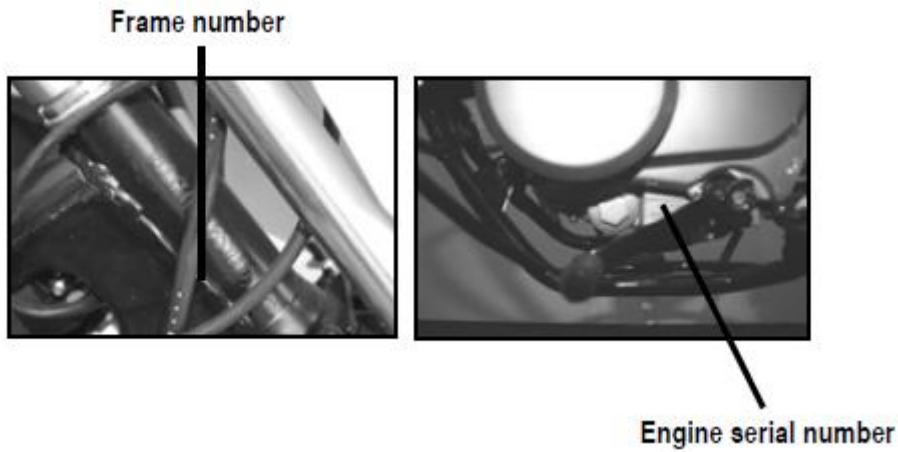

Write down the serial numbers here for your future reference

**Frame No.:**

**Engine No.:**

# WIRE DIAGRAM

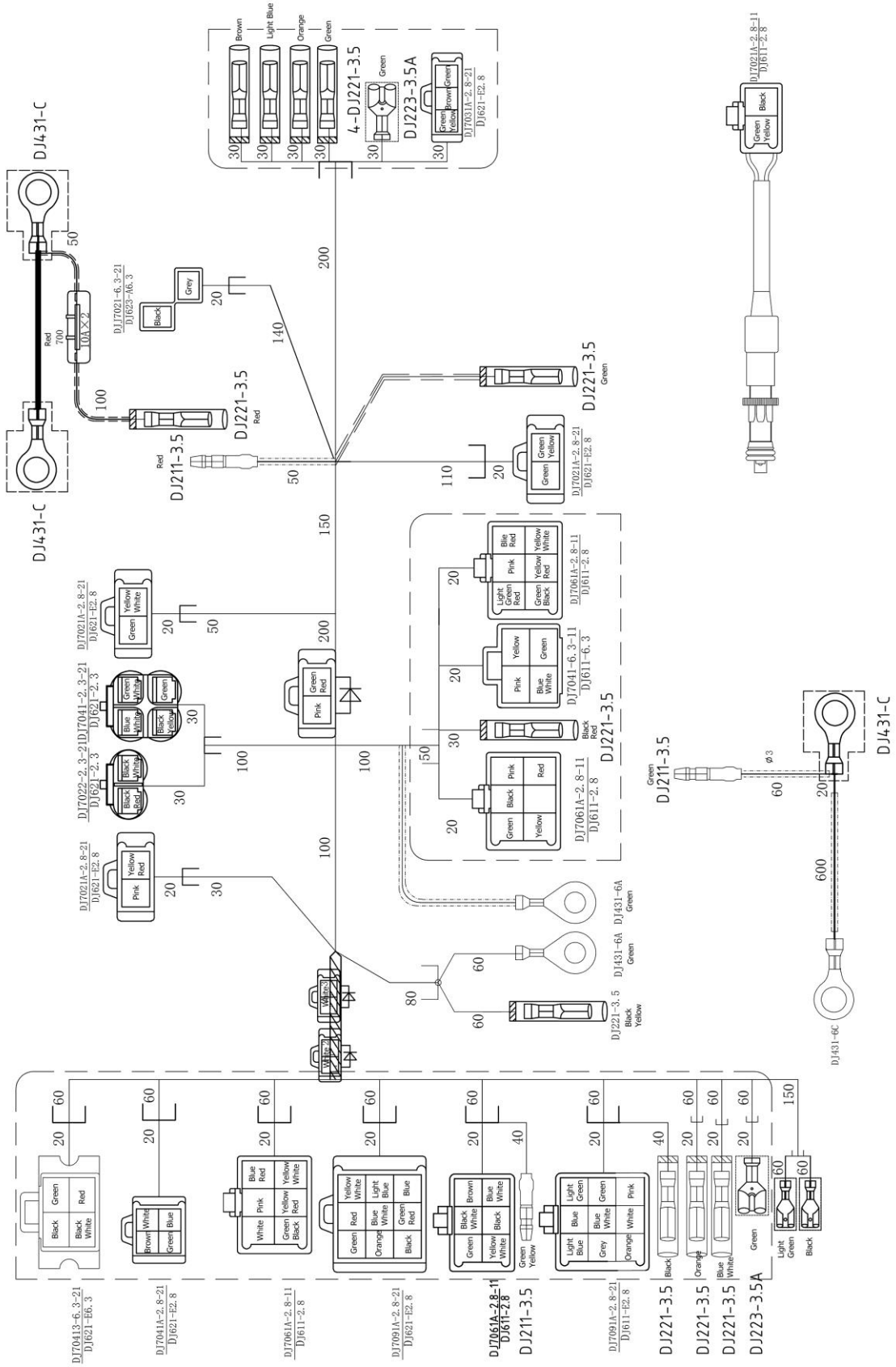

# HMC-EMISSION CONTROL SYSTEM WARRANTY STATEMENT

## YOUR WARRANTY RIGHTS AND OBLIGATIONS

The U.S. Environmental Protection Agency and Ricky Power Sports, LLC (hereinafter **MFR**), are pleased to explain this Emission Control System Warranty on your motorcycle. New motor vehicles must be designed, built, and equipped to meet U.S. EPA standards. **MFR** must warrant the emission control system on your motorcycle for the period of time listed below provided there has been no abuse, neglect or improper maintenance of your motorcycle.

A Warranty Statement: Replacement Parts, Service and Warranty. Any certification issued under this procedure is conditional upon full compliance with the design and defects emissions warranty requirements in the Federal Clean Air Act (42 U.S.C. §7401 et seq) for the applicable useful life (as specified in 40 CFR 86.402-78) in which the engine is installed.

Your emission control system may include components such as the carburetor or fuel-injection system, the ignition system, catalytic converter and engine computer. Hoses, belts, connectors and other emission-related assemblies may also be included.

Where a warrantable condition exists, **MFR** will repair your motorcycle at no cost to you, including diagnosis, parts and labor.

## MANUFACTURER'S WARRANTY COVERAGE

- The warranty period begins on the date the motorcycle is delivered to the first vehicle owner and subsequently continuous to the ultimate vehicle owner thereafter and covers the useful life of the HMC per for 12,000 km (7,456 miles) or 5 (five) years from the date of initial retail delivery, whichever first occurs.

If an emission-related component on your motorcycle is defective, the defective parts will be repaired or replaced by **MFR**. This is your Emission Control System DEFECTS WARRANTY.

## OWNER'S WARRANTY RESPONSIBILITIES

- As a motorcycle owner, you are responsible for the performance of the required maintenance listed in your owner's manual. **MFR** recommends that you retain all receipts covering maintenance on your motorcycle, but **MFR** cannot deny warranty solely for the lack of receipts or for your failure to ensure the performance of all scheduled maintenance.
- You are responsible for presenting your motorcycle to a **MFR** dealer as soon as a problem exists. The warranty repairs should be completed in a reasonable amount of time, not to exceed 30 days.
- As the motorcycle owner, you should be aware that **MFR** may deny your warranty coverage if your motorcycle or a part has failed due to abuse, neglect, improper maintenance or unapproved modifications.
- In case no **MFR** authorized dealer is in the vicinity, the **MFR** warranted vehicle's repair can be conducted by a local licensed mechanic workshop. **MFR** will reimburse the ultimate vehicle owner for all expenses including diagnosis, warranted part(s) and repair labor charges once paid by the ultimate vehicle owner. **MFR** will deliver warranted parts to the licensed mechanic workshop or the ultimate vehicle owner for the Warranty repair job done at the **MFR** approved licensed mechanic workshop at vehicle owner's convenience with no cost to the ultimate vehicle owner.
- The ultimate vehicle owner will be required to send the original copy of receipt of repairs conducted by the licensed mechanic workshop for reimbursement by the **MFR**.

If you have any questions regarding your warranty rights and responsibilities, you should contact **MFR** by the Toll Free 1-844-250-2199. You can always contact U.S. Environmental Protection Agency, 2000 Traverwood Drive, Ann Arbor, MI 48105 for any Emission Control System Warranty related complaints about the **MFR**. But for actual Warranty related repair job, you should only contact **MFR** by Warranty service number printed on this Warranty statement included in the Owner's Manual or on **MFR's** website; or the Dealer where your vehicle is purchased, or other **MFR** authorized local Dealer near you.

### LIMITED WARRANTY ON EMISSION CONTROL SYSTEM

**MFR** warrants that each new **MFR** motorcycle, which includes as standard equipment a headlight, taillight and stoplight, and is street legal:

- A. is designed, built and equipped so as to conform at the time of initial retail purchase with all applicable regulations of the United States Environmental Protection Agency and section 42 USC §7521.
  - B. is free from defects in material and workmanship which cause such motorcycle to fail to conform with applicable regulations of the United States EPA for a period of use of:  
12,000 km (7,456 miles) or 5 (five) years from the date of initial retail delivery, whichever first occurs.
1. **COVERAGE.** Warranty defects shall be remedied during customary business hours at any **MFR** authorized dealer or a licensed mechanic located within the United States of America in compliance with the Federal Clean Air Act and applicable regulations of the United States Environmental Protection Agency. Any part or parts replaced under this warranty shall become the property of **MFR**.
  2. **LIMITATIONS.** This Emission Control System Warranty shall not cover any of the following:
    - A. Repair or replacement required as a result of
      - a) accident;
      - b) misuse;
      - c) repairs improperly performed or replacements improperly installed;
      - d) use of replacement parts or accessories not conforming to **MFR's** specifications which adversely affect performance and/or
      - e) use in competitive racing or related events.
    - B. Inspections, replacement of parts and other services and adjustments required for required maintenance.
    - C. Any motorcycle on which the odometer mileage has been changed so that actual mileage cannot be readily determined.
  3. **LIMITED LIABILITY**
    - A. The liability of **MFR** under this Emission Control System Warranty is limited solely to the remedying of defects in material workmanship by a **MFR** authorized dealer at its place of business during customary business hours. This warranty does not cover inconvenience or loss of use of the motorcycle or transportation of the motorcycle to or from the **MFR** dealer. **MFR SHALL NOT BE LIABLE FOR ANY OTHER EXPENSES, LOSS OR DAMAGE, WHETHER DIRECT, INCIDENTAL, CONSEQUENTIAL OR EXEMPLARY ARISING IN CONNECTION WITH THE SALE OR USE OF OR INABILITY TO USE THE MFR VEHICLE FOR ANY PURPOSE. SOME STATES DO NOT ALLOW THE EXCLUSION OR LIMITATION OF ANY INCIDENTAL OR CONSEQUENTIAL DAMAGES, SO THE ABOVE LIMITATIONS MAY NOT APPLY TO YOU.**
    - B. **NO EXPRESS EMISSION CONTROL SYSTEM WARRANTY IS GIVEN BY MFR EXCEPT AS SPECIFICALLY SET FORTH HEREIN. ANY EMISSION CONTROL SYSTEM WARRANTY IMPLIED BY LAW, INCLUDING ANY WARRANTY OF THE MERCHANTABILITY OR FITNESS FOR A PARTICULAR PURPOSE, IS LIMITED TO THE EXPRESS EMISSION CONTROL SYSTEM WARRANTY TERMS STATED IN THIS WARRANTY. THE**

FOREGOING STATEMENTS OF WARRANTY ARE EXCLUSIVE AND IN LIEU OF ALL OTHER REMEDIES. SOME STATES DO NOT ALLOW LIMITATIONS ON HOW LONG AN IMPLIED WARRANTY LASTS SO THE ABOVE LIMITATIONS MAY NOT APPLY TO YOU.

C. No dealer is authorized to modify this Limited Emission Control System Warranty.

4. LEGAL RIGHTS. THIS WARRANTY GIVES YOU SPECIFIC LEGAL RIGHTS, AND YOU MAY ALSO HAVE OTHER RIGHTS WHICH VARY FROM STATE TO STATE
5. THIS EMISSION CONTROL SYSTEM WARRANTY IS IN ADDITION TO THE **MFR** GENERAL MOTORCYCLE LIMITED WARRANTY.
6. THE EMISSION CONTROL SYSTEM WARRANTY REPAIRS ELIGIBILITY EVALUATION Your vehicle's eligibility for **MFR** Warranty repairs shall be evaluated by **MFR** or at **MFR** authorize Dealer's store where your vehicle is purchased. If Warranty repair is done at a local licensed mechanic workshop (with Lic #), the ultimate vehicle owner is required to call or email **MFR** and provide the following information for Warranty repairs eligibility evaluation prior to your Warranty Claims:
  - Invoice number and purchase date;
  - VIN number of the vehicle;
  - Picture of the faulty parts;
  - Labor charge for the repairs quoted by the mechanic workshop.
7. EMISSION CONTROL SYSTEM WARRANTY PARTS DELIVERY AND LABOR CHARGE REIMBURSEMENT
  - A. **MFR** will deliver the repair parts at no cost to the ultimate vehicle owner or the licensed mechanic workshop you choose (if no **MFR** authorized local dealer is available), using express mail once your vehicle Warranty repairs eligibility is established.
  - B. The ultimate vehicle owner has to mail in the actual repair cost receipts to **MFR** for reimbursement.
  - C. **MFR** will reimburse the ultimate vehicle owner the Warranty repair labor cost once your Warranty repair is completed by the approved local licensed mechanic workshop.
8. ADDITIONAL INFORMATION
  - **MFR** recommend that OEM parts be used when Warranty repairs are needed. Nonetheless, any replacement part that is equivalent in performance and durability may be used in the performance of any maintenance or repairs. The **MFR** Warranty is still effective under such circumstance. However the ultimate vehicle owner is responsible for the performance of all required maintenance listed in your Owner's Manual.
  - **MFR** recommends that you retain all receipts covering maintenance on your vehicle, but **MFR** cannot deny warranty solely for the lack of receipts or for your failure to ensure the performance of all scheduled maintenance.
9. CUSTOMER COMPLAINTS AND WARRANTY CLAIMS TRACKING

To ensure Warranty parts, complaints and repairs are handled and tracked securely and timely, each Customer Warranty Claim is input into our data base by the retail Dealer/wholesale Dealer via company website. Warranty Claims will be reported which we then review for Warranty Claims tracking management, parts, and credit processing for individual customers.

<https://www.therps.net> Service Email: rickypowersports@gmail.com

#### 10. EMISSION DEFECT REPORT TO GOVERNING BODY

**MFR** will monitor Warranty Claims entry in a timely manner and will report to EPA once such specific emission-related defects exist in twenty-five (25) or more vehicles or engines of the same model year, per 40 CFR §85.1903(a)(2).



**PROMAX**  
**MSX** CROM